



KONVEKTA

Thermo Systems

Ersatzteilliste Taurus *spare part list Taurus*



Optionen

mit Frischluft
mit Heizung
mit CAN

Options

with fresh air
with heating
with CAN

Konvekta AG

Am Nordbahnhof 5
34613 Schwalmstadt
Germany

Tel.: +49 (0) 66 91 / 76 – 0
Fax.: +49 (0) 66 91 / 76 - 200
Info@konvekta.com
www.konvekta.com

Allgemeines

Verehrter Kunde, die vorliegende Ersatzteilliste enthält Angaben, die für die Ersatzteilbestellung erforderlich sind. Nur Originalersatzteile gewährleisten Qualität, Sicherheit und Austauschbarkeit. Die Firma KONVEKTA AG übernimmt keine Verantwortung für Schäden, die durch Verwendung firmenfremder Bauteile entstehen. Manipulieren an den Bauteilen selbst oder an vorhandenen Einstellungen ist zu unterlassen! Alle Originalersatzteile dürfen nur bestimmungsgemäß verwendet werden. Wartungsarbeiten an Konvekta-Produkten dürfen nur durch geschultes Personal im Bereich Kälteanlagenbau durchgeführt werden. Bestehende Unfallverhütungsvorschriften und Gesetze müssen in jedem Fall eingehalten werden.

Weitere Hinweise entnehmen Sie bitte unseren

Gewährleistungsrahmenbedingungen, allgemeingültigen Einbaurichtlinien und Sicherheitsvorschriften. Bei Fragen oder Problemen steht Ihnen unser Servicedienst jederzeit gern zur Verfügung. Durch Weiterentwicklung entstehende konstruktive und technische Änderungen behalten wir uns vor. Irrtum vorbehalten. Die Abbildungen in dieser Liste sind unverbindlich. **Für eine Ersatzteilbestellung sind folgende Angaben erforderlich:** - Gerätetyp, Auftrags bzw. Seriennummer (siehe Typenschild) - KONVEKTA Bestellnummer der gewünschten Teile - Bezeichnung der Teile (siehe entsprechende Texterklärung) - Stückzahl - Ihre genaue Versandanschrift - Versandart (z.B. Post, Fracht oder Express) Wir wünschen Ihnen eine problemlose und störungsfreie Wartung / Reparatur Ihrer Anlage.

Generally

Dear customer, the spare part list you have at hand contains specifications which are necessary for ordering spare parts. Only original spare parts guarantee quality, safety and exchangeability. KONVEKTA AG does not assume responsibility for damages which are caused by employment of parts from other companies. It has to be refrained from manipulating parts or existing adjustments! All original spare parts may be used only in accordance with the requirements. Servicing work on Konvekta products may be carried out only by trained staff in the area of Refrigerant plant construction. Existing accident prevention regulations and statute must be kept, in any case. **For further information please refer to our guarantee, warranty and safety instructions.** In case of arising problems our after-sales service is at your disposal at any time. We reserve the right of constructional and technical alterations resulting from further development. Mistake reserve. The illustrations in this list are without obligation. **When ordering spare parts the following specifications have to be made:** - type of unit, order confirmation no. / resp. Serial no. (please refer to the type plate) - KONVEKTA part-no. Of the ordered parts. - specification of the parts (pls refer to the corresponding text description) - quantity - your exact delivery address - means of transport (for instance Postal Service, freight or express) We hope you have a problem and trouble-free service / repair of your unit.
The management

Änderungsverlauf History of modification



Version	Datum	Name	Bemerkung	Datei
version	date	name	remark	file
a00	11.09.2019	Jochen Streck	Erstellung	KL9T00-ET-a00
a01	27.01.2021	Jochen Streck	BKL-4300249T03 und -04 hinzu	KL9T00-ET-a01
a02	01.04.2021	Jochen Streck	Pos.11 ET-03 war H35-050-023	KL9T00-ET-a02

Variantenübersicht variants overview

Artikelnr. part no.	Typ type	Steuerung control	Heizung heating	Frischluf fresh air
BKL-4300249T01	6xVD-4St./KD-1St.	Relais	---	---
BKL-4300249T02	8xVD-BL/KD-2St./CAN	Wabco	X	X
BKL-4300249T03	6xVD-4St./KD-1St.	Relais	---	---
BKL-4300249T04	8xVD-4St./KD-1St.	Relais	---	---

Taurus-ET01



Thermo Systems

KÜHL- & KLIMAMANLAGEN D-34607 SCHWALMSTADT

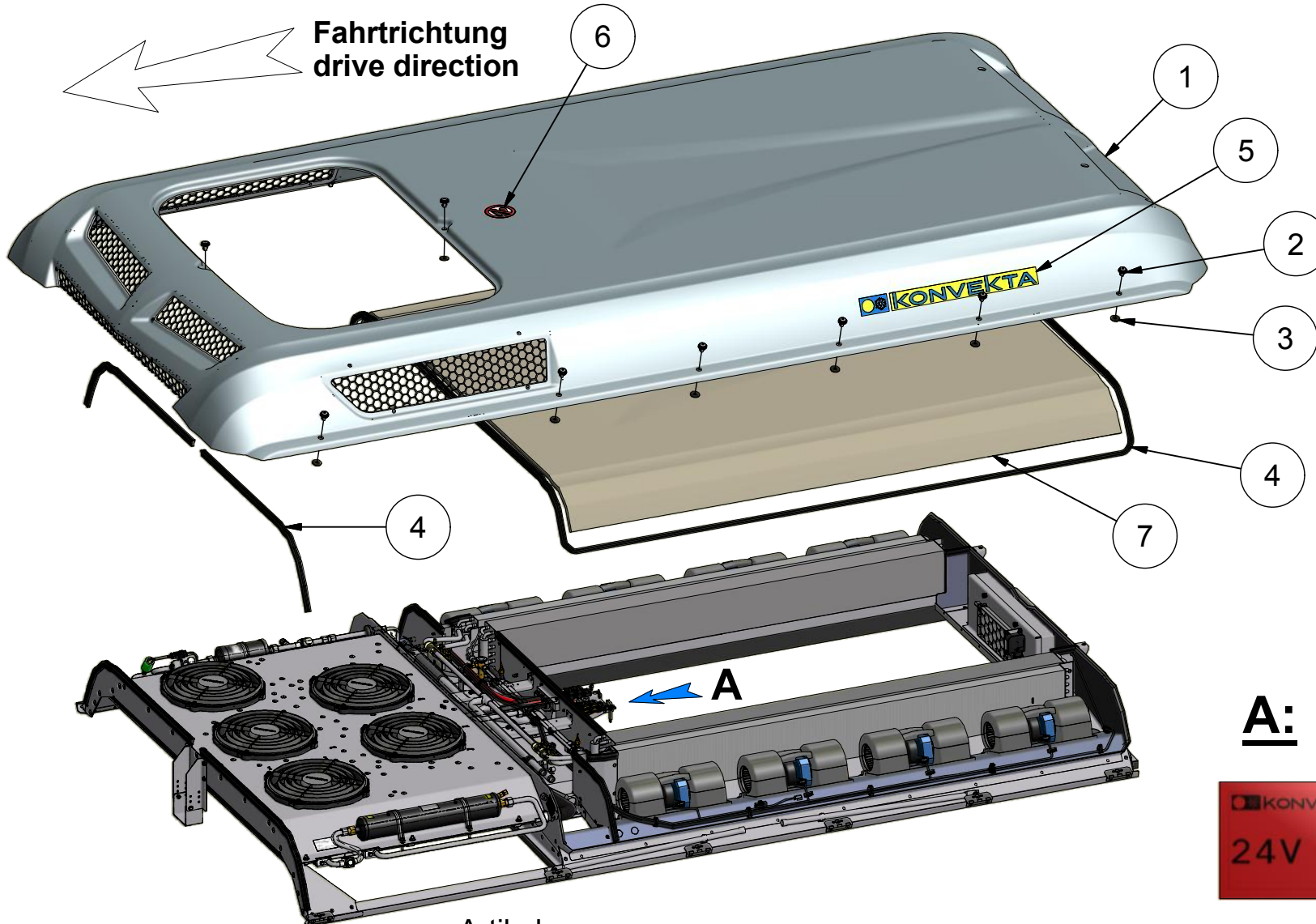

Fahrtrichtung
drive direction





Artikelnummer
Part number
Numéro d'article
Número de artículo
Bezeichnung / Designation
Désignation / Denominación

Artikelnummer	Index
Bezeichnung	DIN/Maß
Serien-Nr.:	M / Jahr
34607 Schwalmstadt / Tel.: 06691 - 76-0 / Fax: -111	

Artikelnummer	Ind.
Bezeichnung	
Serien-Nr.:	
geprüft am:	Datum

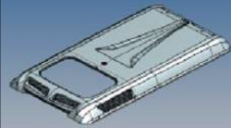

Artikel Nr.
 Part no.

BKL-4300249T01	BKL-4300249T02	BKL-4300249T03	BKL-4300249T04																	
----------------	----------------	----------------	----------------	--	--	--	--	--	--	--	--	--	--	--	--	--	--	--	--	--

Pos pos	Artikel Nr. Part no:	Bild picture	Bezeichnung description		Menge pro Anlage quantity per unit																
1	B59-AA1-172		Abdeckhaube Taurus komp. cover TAURUS compl.	R10.000, RAL9010 R10.000, RAL9010	1	1	1	1													
2	H14-004-206		Verschlußbolzen (3Telf.+1PA) locking bolt (3 spring washers	mit Stift 800-611 / 17,95 mm with pin 800-611 / 17,95 mm	14	14	14	14													
3	H14-004-208		U-Scheibe/EPDM washer EPDM	ø 8,2xø30,0x 2,0mm ø 8,2xø30,0x 2,0mm	14	14	14	14													
4	H14-002-457		Dichtungsprofil profile sealing black	schwarz black	12	12	12	12													

Artikel Nr.
Part no.

BKL-4300249T01	BKL-4300249T02	BKL-4300249T03	BKL-4300249T04																
----------------	----------------	----------------	----------------	--	--	--	--	--	--	--	--	--	--	--	--	--	--	--	--

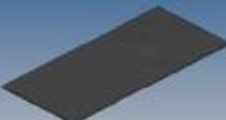
Pos pos	Artikel Nr. Part no:	Bild picture	Bezeichnung description	Menge pro Anlage quantity per unit																
5	H25-000-004		Schild adhesive label "KONVEKTA" "KONVEKTA"	2																
6	H25-002-060		Klebeschild label adhesive Betreten verboten D=100 Betreten verboten D=100	1	1	1	1													
7	H14-007-425		PE-Mat.-Zuschnitt insulating material Abdeckhaube Taurus, 15 mm cover Taurus, 15 mm	2	2	2	2													

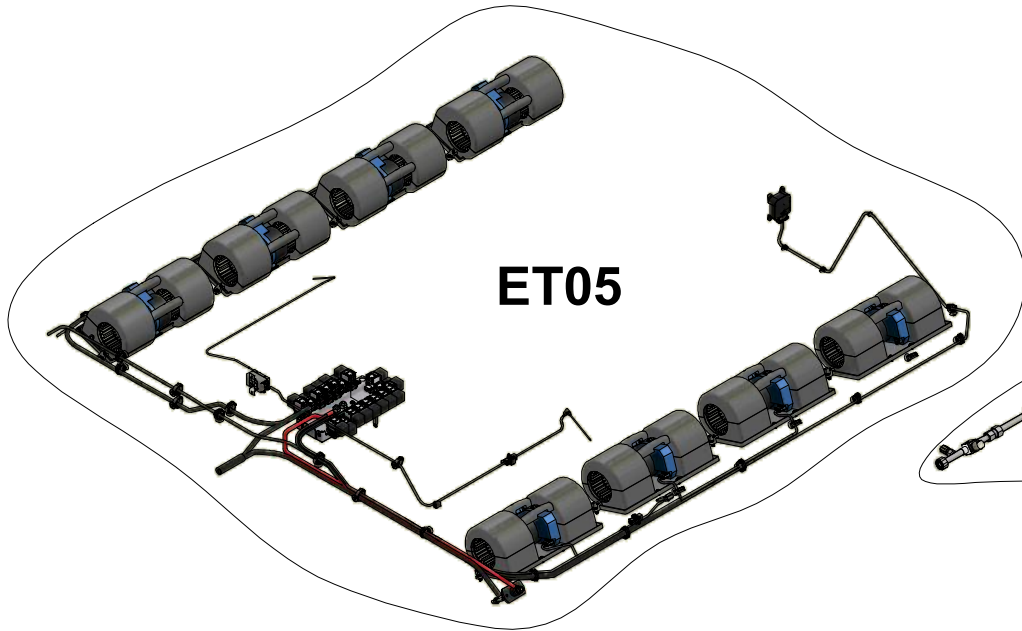

Fahrtrichtung
drive direction

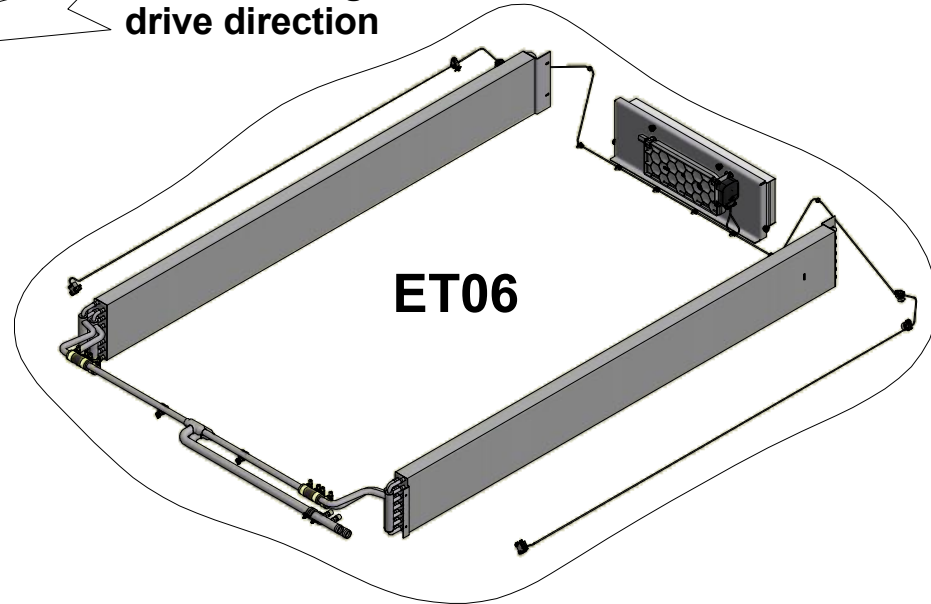

Taurus-ET03



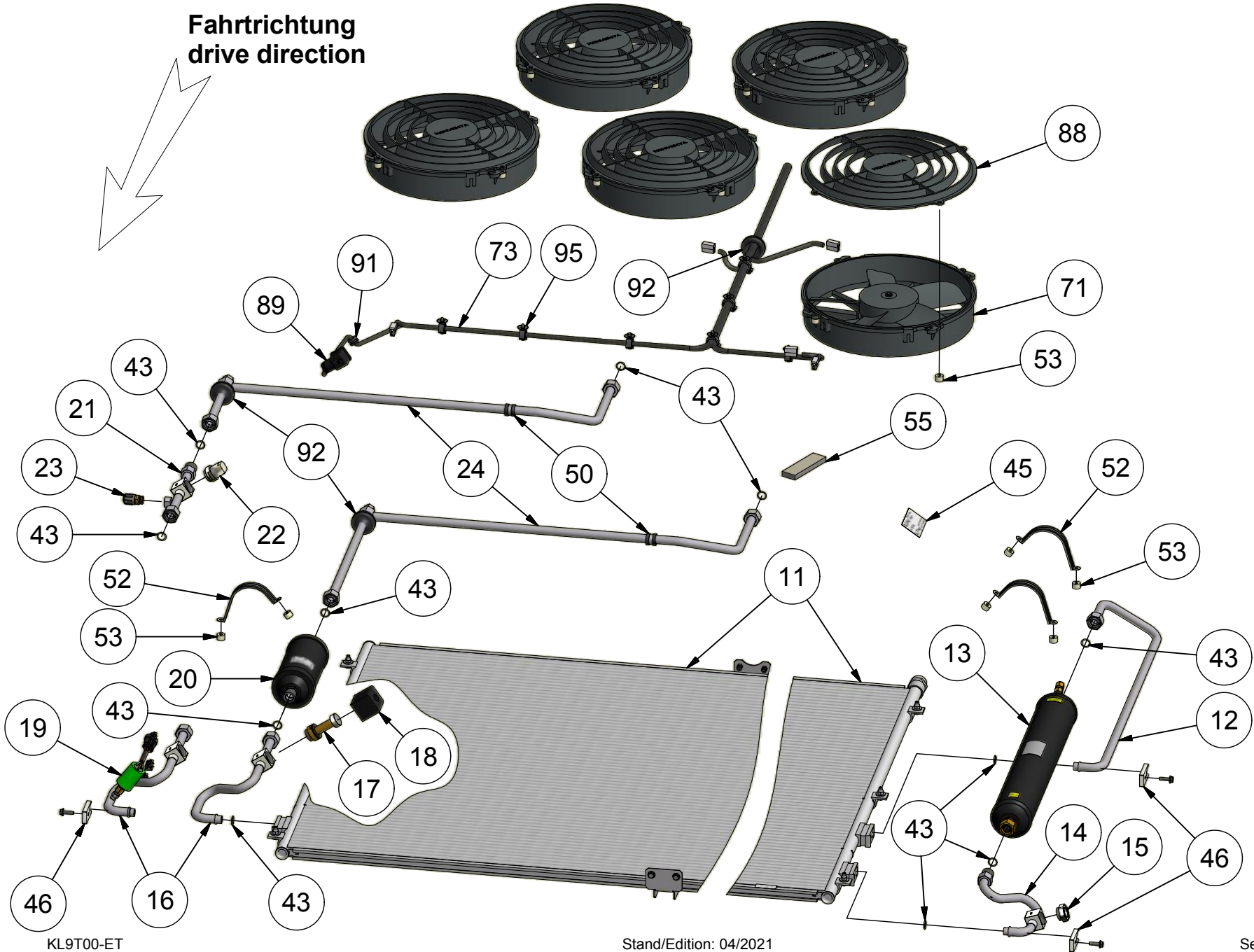

Thermo Systems

KÜHL- & KLIMAMANLAGEN D-34607 SCHWALMSTADT

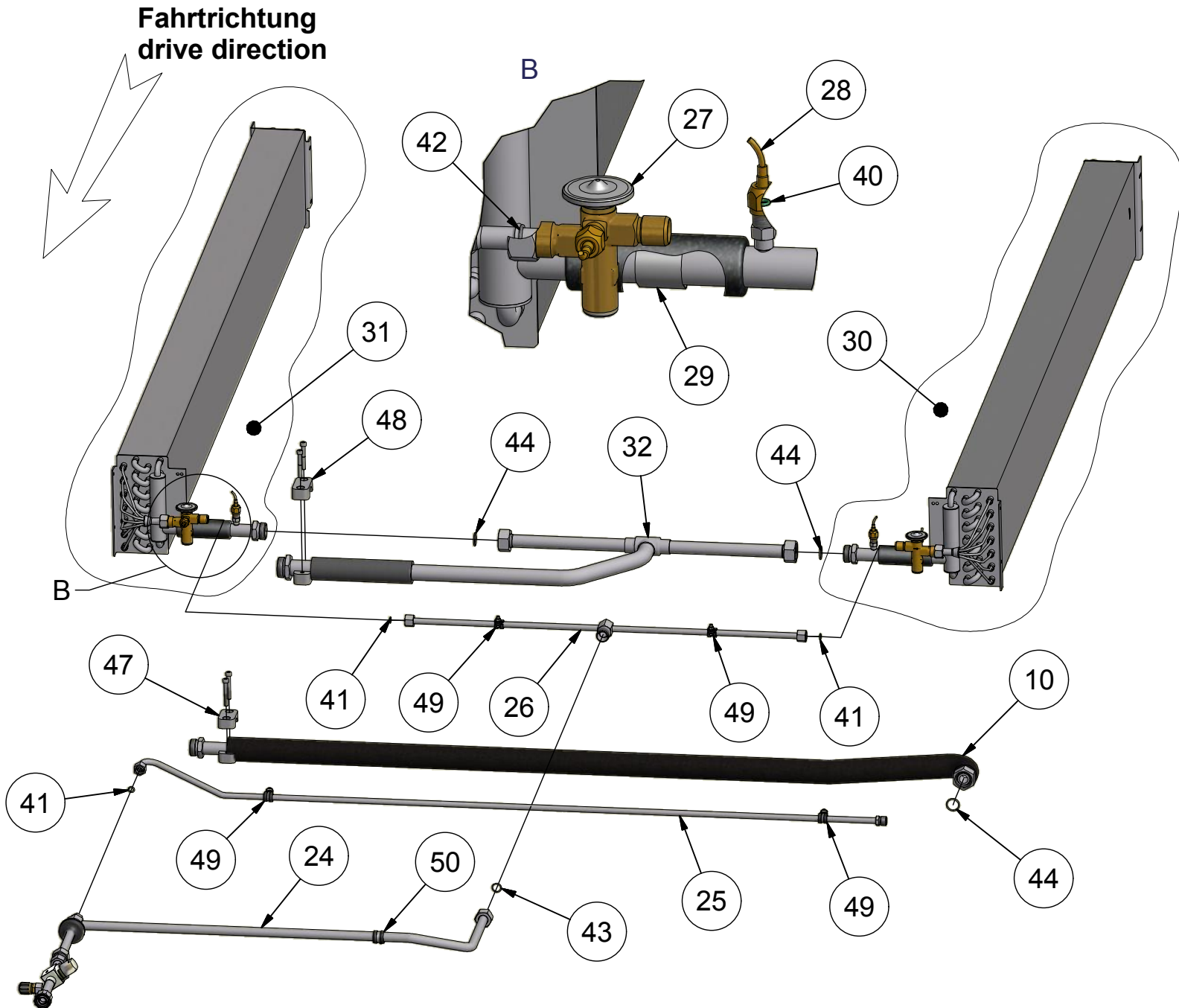

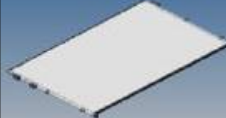

BKL-4300249T01	BKL-4300249T02	BKL-4300249T03	BKL-4300249T04																		
----------------	----------------	----------------	----------------	--	--	--	--	--	--	--	--	--	--	--	--	--	--	--	--	--	--

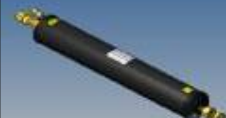



Pos pos	Artikel Nr. Part no:	Bild picture	Bezeichnung description		Menge pro Anlage quantity per unit																																											
10	B52-220-050		Rohrleitung ø22 Al kpl. Taurus Heißgas rechts tubing Taurus hot gas line right		1	1																																										
11	B35-A50-023		Kond.-Batterie condenser coil Flachrohr-KD Taurus 1494x917x20mm		1	1	1	1																																								
12	B52-160-126		Rohrleitung Ø16 kpl. tubing Ø16 complete 2. Pass => Sammler 2. pass => receiver		1	1	1	1																																								
13	H14-005-047		Kältemittelsammler refrigerant receiver 7/8" - O-Ring 7/8" - O-Ring		1	1	1	1																																								

Dachanlage Taurus
Roof Top Unit
Französisch
Spanisch

Ersatzteilliste / Spare Part List
Französisch / Spanish

Artikel Nr.
Part no.

BKL-4300249T01	BKL-4300249T02	BKL-4300249T03	BKL-4300249T04																								
----------------	----------------	----------------	----------------	--	--	--	--	--	--	--	--	--	--	--	--	--	--	--	--	--	--	--	--	--	--	--	--



Pos pos	Artikel Nr. Part no:	Bild picture	Bezeichnung description	Menge pro Anlage quantity per unit																													
14	B52-160-146		Rohrleitung Ø16 kpl. tubing ø16 complete	Sammler => 3. Pass + Schauglas receiver => 3. pass + sight gl	1	1	1	1																									
15	H14-004-023		Einschraubteil Schauglas clamp-in part sight glass	mit Indikator f. H52-000-240 with indicator for H52-000-24	1	1	1	1																									
16	B52-160-128		Rohrleitung Ø16 kpl. tubing Ø16 complete	3. Pass => Trockner 3. pass => dryer	1		1	1																									
16	B52-160-147		Rohrleitung Ø16 kpl. tubing Ø16 complete	3. Pass => Trockner + 7/16" 3. pass => dryer + 7/16"		1																											

Dachanlage Taurus
Roof Top Unit
Französisch
Spanisch



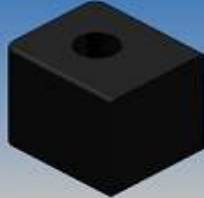

Ersatzteilliste / Spare Part List
Französisch / Spanish

Artikel Nr.
Part no.



BKL-4300249T01	BKL-4300249T02	BKL-4300249T03	BKL-4300249T04																			
----------------	----------------	----------------	----------------	--	--	--	--	--	--	--	--	--	--	--	--	--	--	--	--	--	--	--

Pos pos	Artikel Nr. Part no:	Bild picture	Bezeichnung description		Menge pro Anlage quantity per unit																						
17	H11-002-323		Einschraubteil Magn.-Ventil clamp-in part magnetic valve	o. Spule f. H52-000-240 w/o coil for H52-000-240	1	1	1	1																			
18	H11-001-304		Spule f. M.-Ventil coil for solenoid valve 24Volt	24 Volt DC (O-Ring) 24 Volt DC(o-ring)	1	1	1	1																			
19	B11-AB2-324		Druckschalter 7/16" i switch pressure 7/16" i	11,0-16,0 bar / R134a 11,0-16,0 bar / R134a		1																					
20	H14-001-058-1		Trockner 7/8" O-Ring drier 7/8" O-Ring	ARI Standard 710-86 / DIN8949 ARI Standard 710-86 / DIN8949	1	1	1	1																			

BKL-4300249T01	BKL-4300249T02	BKL-4300249T03	BKL-4300249T04																	
----------------	----------------	----------------	----------------	--	--	--	--	--	--	--	--	--	--	--	--	--	--	--	--	--

Pos pos	Artikel Nr. Part no:	Bild picture	Bezeichnung description		Menge pro Anlage quantity per unit																
21	B52-160-139		Rohrleitung Ø16 kpl. tubing Ø16 complete	Trockner => E-Ventile, Absperr dryer => e-valve, shut-off val	1	1	1	1													
22	H14-004-024		Einschraubteil H.-Absperrvent. clamp-in part shut-off valve	Schlüsselbetät. f. H52-000-240 for H52-000-240	1	1	1	1													
23	H14-001-114		Füllventil (R134a) filling valve R134a pressure	f. Druckseite for pressure side	1	1	1	1													
24	B52-160-129		Rohrleitung Ø16 kpl. tubing Ø16 complete	Trockner => E-Ventile dryer => e-valve																	

BKL-4300249T01	BKL-4300249T02	BKL-4300249T03	BKL-4300249T04																	
----------------	----------------	----------------	----------------	--	--	--	--	--	--	--	--	--	--	--	--	--	--	--	--	--

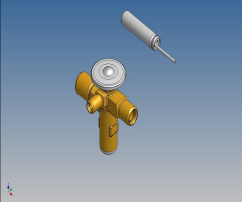

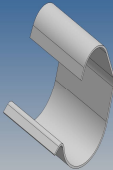
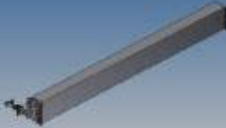
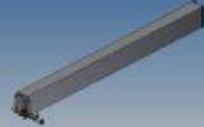

Pos pos	Artikel Nr. Part no:	Bild picture	Bezeichnung description		Menge pro Anlage quantity per unit																
24	B52-160-140		Rohrleitung Ø16 kpl. tubing Ø16 complete	Absperrventil => E-Ventile shut-off valve => e-valve	1	1	1	1													
25	B52-100-049		Rohrleitung ø10 Al tubing ø10 aluminum	Taurus Frontbox Taurus Frontbox		1															
26	B52-160-131		Rohrleitung Ø16 kpl. tubing Ø16 complete	T-Stück => E-Ventile t joint => e-valve	1	1	1	1													
27	H14-004-055		Expansionsventil valve expansion	TOEX/Gr.4,5S/R134a/ 5/8"x3/4" D TOEX/Gr.4,5S/R134a/ 5/8"x3/4" D	2	2	2	2													

BKL-4300249T01	BKL-4300249T02	BKL-4300249T03	BKL-4300249T04																	
----------------	----------------	----------------	----------------	--	--	--	--	--	--	--	--	--	--	--	--	--	--	--	--	--



Pos pos	Artikel Nr. Part no:	Bild picture	Bezeichnung description		Menge pro Anlage quantity per unit																
28	H14-001-068		Kapillarrohr(O-Ring) capillary tube (O-ring) 600 mm	600mm lg. 7/16" 600mm long	2	2	2	2													
29	H14-004-056		Clips f. E-Ventil clip for expansion valve	D=12 / D=22 D=12 / D=22	2	2	2	2													
30	B30-A30-069		Verd.-Batterie Taurus li. EV. evaporator coil Taurus le. EV.	1600L07RH25,4/04RT22 1600L07RH25,4/04RT22	1	1	1	1													
31	B30-A30-070		Verd.-Batterie Taurus re. EV. evaporator coil Taurus ri. EV.	1600L07RH25,4/04RT22 1600L07RH25,4/04RT22	1	1	1	1													

Artikel Nr.
Part no.

BKL-4300249T01	BKL-4300249T02	BKL-4300249T03	BKL-4300249T04																	
----------------	----------------	----------------	----------------	--	--	--	--	--	--	--	--	--	--	--	--	--	--	--	--	--



Pos pos	Artikel Nr. Part no:	Bild picture	Bezeichnung description		Menge pro Anlage quantity per unit																
32	B52-280-056		Rohrleitung ø28 Al tubing Ø16 complete	Taurus Saugleitung Taurus suction tube	1	1	1	1													
40	H14-001-149		O-Dichtring o-ring sealing NW6, 7/16" (R 1	7/16", NW 6, R134a 7/16",NW6, R134a	4	4	4	4													
41	H12-000-715		O-Dichtring o-ring sealing NW 8, 5/8"	5/8", NW 8, R134a 5/8", NW 8, R134a	3	4	3	3													
42	H12-000-716		O-Dichtring o-ring sealing 3/4", NW10, R 1	3/4", NW10, R134a 3/4", NW10, R134a	2	2	2	2													

BKL-4300249T01	BKL-4300249T02	BKL-4300249T03	BKL-4300249T04																	
----------------	----------------	----------------	----------------	--	--	--	--	--	--	--	--	--	--	--	--	--	--	--	--	--



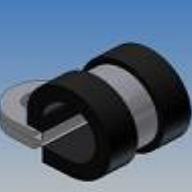
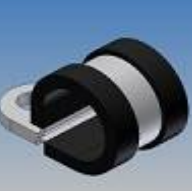

Pos pos	Artikel Nr. Part no:	Bild picture	Bezeichnung description		Menge pro Anlage quantity per unit																
					BKL-4300249T01	BKL-4300249T02	BKL-4300249T03	BKL-4300249T04													
43	H12-000-717		O-Dichtring o-ring sealing NW 12, 7/8"	7/8", NW12, R134a 7/8", NW12, R134a	8	8	8	8													
44	H14-002-107		O-Dichtring o-ring sealing NW 20	NW 20 NW 20	3	3	3	3													
45	B25-CI2-063	5,2 kg Füllmenge Charge R134a 5,7 kg mit Frontbox with Frontbox	Klebeschild Taurus adhesive label	Füllmenge charge	1	1	1	1													
46	B56-160-564		Halteplatte /SL holding plate	7/8" O-Ring für H14-004-044 7/8" o-Ring for H14-004-044	3	3	3	3													

Artikel Nr.
Part no.

BKL-4300249T01	BKL-4300249T02	BKL-4300249T03	BKL-4300249T04																	
----------------	----------------	----------------	----------------	--	--	--	--	--	--	--	--	--	--	--	--	--	--	--	--	--

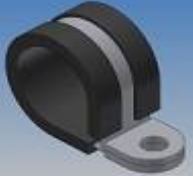
Pos pos	Artikel Nr. Part no:	Bild picture	Bezeichnung description		Menge pro Anlage quantity per unit																
47	H14-002-258		Rohrschelle clip pipe	ø 22 ø 22		1															
48	H14-002-275		Rohrschelle clip pipe	ø 28 - Polyamid ø 28 - Polyamid	1	1	1	1													
49	H14-000-202		Schlauchschelle hose clip with rubber prof. 10	10/12 10/12	2	4	2	2													
50	H14-003-264		Schlauchschelle hose clip	16/15 16/15	1	3	1	1													

BKL-4300249T01	BKL-4300249T02	BKL-4300249T03	BKL-4300249T04																	
----------------	----------------	----------------	----------------	--	--	--	--	--	--	--	--	--	--	--	--	--	--	--	--	--

Pos pos	Artikel Nr. Part no:	Bild picture	Bezeichnung description		Menge pro Anlage quantity per unit																
51	H14-002-260		Schlauchschelle hose clip	22/15 W5 22/15 W5		2															
52	H14-000-298		Schlauchschelle hose clip	43/15 43/15	3	3	3	3													
53	H15-001-312		Distanzstück piece spacer	10x15x6,3mmø 10x15x6,3mmø	26	6	26	26													
54	H14-003-224		Doppelklammer double clamp	Klemmbereich 1,0-1,5/1,8-2,5 1,0-1,5/1,8-2,5	4	4	4	4													

Ersatzteilliste / Spare Part List
Französisch / Spanish

Dachanlage Taurus
Roof Top Unit
Französisch
Spanisch

Artikel Nr.
Part no.

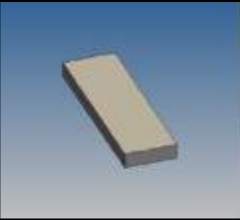

BKL-4300249T01	BKL-4300249T02	BKL-4300249T03	BKL-4300249T04																	
----------------	----------------	----------------	----------------	--	--	--	--	--	--	--	--	--	--	--	--	--	--	--	--	--

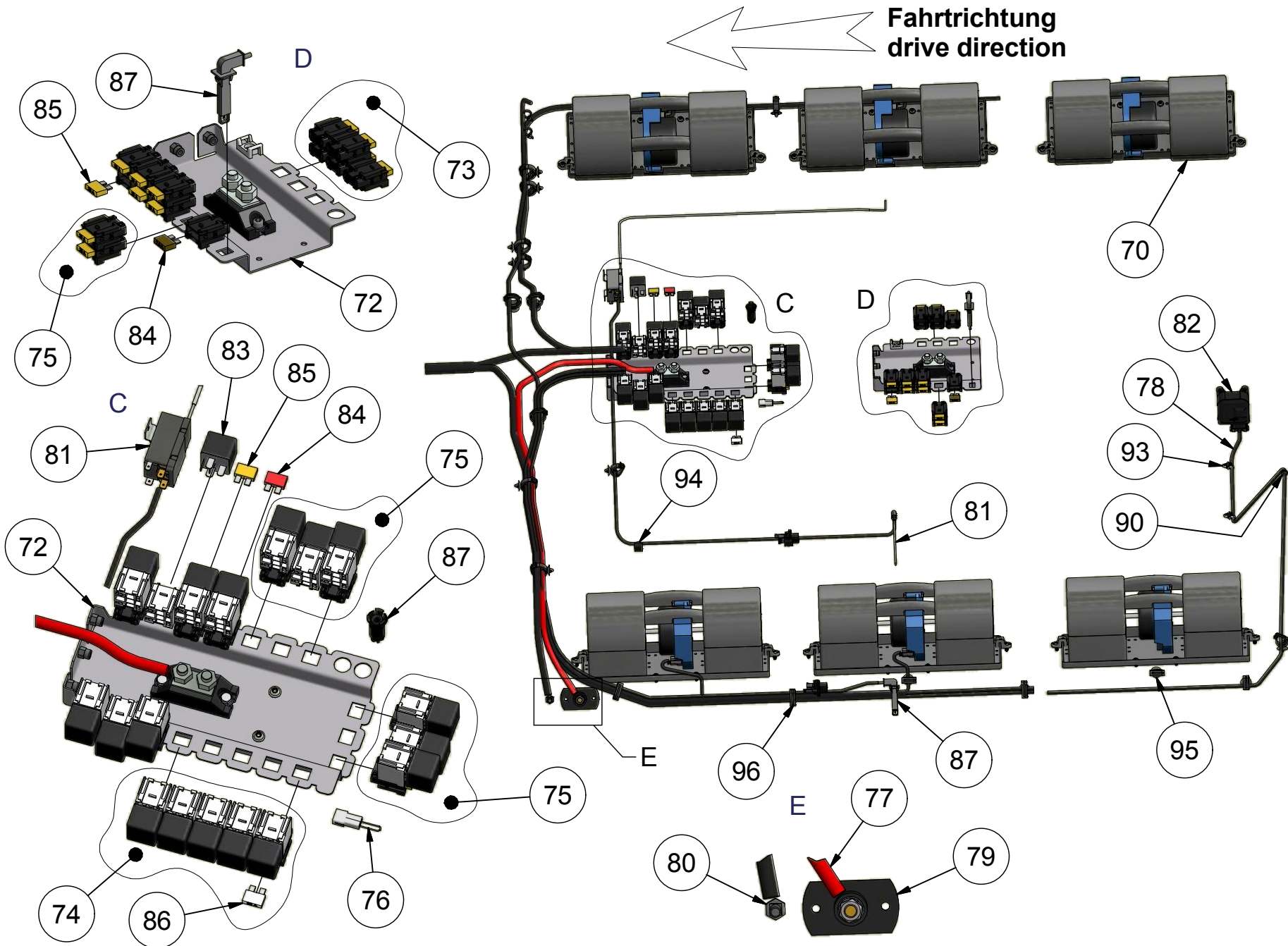
Pos pos	Artikel Nr. Part no:	Bild picture	Bezeichnung description		Menge pro Anlage quantity per unit																												
55	H14-002-495		Dichtstreifen tape sealing	2000x 30 x10mm 2000x 30 x10mm	0,3	0,4	0,3	0,3																									





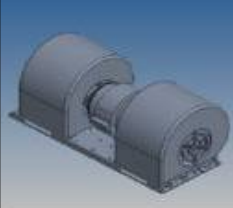
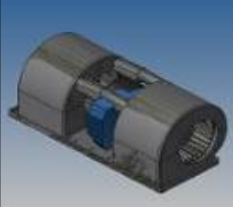

Artikel Nr.
Part no.

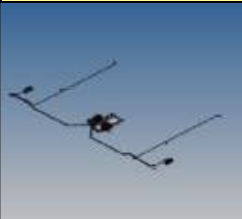

BKL-4300249T01	BKL-4300249T02	BKL-4300249T03	BKL-4300249T04																
----------------	----------------	----------------	----------------	--	--	--	--	--	--	--	--	--	--	--	--	--	--	--	--

Pos pos	Artikel Nr. Part no:	Bild picture	Bezeichnung description		Menge pro Anlage quantity per unit															
70	H11-003-247		Doppelgebläse double radial blower	24V/1stufig/1050 m³/h 24V/1stufig/1050 m³/h	6			6	8											
70	H11-002-259		Doppelgebläse Basic double radial blower basic	24V/stufenl. regelb. bl 24V/infinately variable			8													
71	H11-003-252		Axialventilator axial ventilator	24V/1stufig/2820 m³/h 24V/1speed/2820 m³/h	5			5	5											
71	H11-003-201		Axialventilator ø300 Premium axial ventilator ø300 premium	24V/stufenl. regelb. 24V/infinately variable			5													



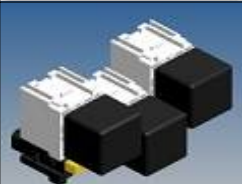

BKL-4300249T01	BKL-4300249T02	BKL-4300249T03	BKL-4300249T04																	
----------------	----------------	----------------	----------------	--	--	--	--	--	--	--	--	--	--	--	--	--	--	--	--	--

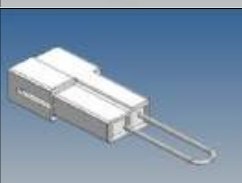
Pos pos	Artikel Nr. Part no:	Bild picture	Bezeichnung description	Menge pro Anlage quantity per unit																
72	BK1-400-104		Kabelstrang kpl. KL47/48/T 24V Basis, 4-VD Gebl.,1-Kreis,UL cable harness complete KL47/48 basic, 4-blowers, 1-cycle, UL	1																
72	BK1-400-139		Kabelstrang KL48/Taurus VD 24 ATCCAN bl.Gebälse/-Lüfter,FL cable harn. KL48T/Tau 24V com. ATCCAN bl.blower/- fans, Fresha	1																
73	BK1-011-358		Kabelstrang KD TAURUS 5 KD-Lüfter 1-stufig cable harness CD Taurus 5 CD-Fans 1-step	1																
73	BK1-012-159		Kabelstrang Taurus KD 5 bl Lüfter, MV, Druckschalter cable harness Cond. Taurus 5 brushl.fans, MV, press.switc	1																





BKL-4300249T01	BKL-4300249T02	BKL-4300249T03	BKL-4300249T04																	
----------------	----------------	----------------	----------------	--	--	--	--	--	--	--	--	--	--	--	--	--	--	--	--	--

Pos pos	Artikel Nr. Part no:	Bild picture	Bezeichnung description	Menge pro Anlage quantity per unit																																					
				BKL-4300249T01	BKL-4300249T02	BKL-4300249T03	BKL-4300249T04																																		
74	BK1-000-361		Kabelstrang KD TAURUS cable harness CD Taurus	F9 - F13, K14 - K18 für KD 1st F9 - F13, K14 - K18 for CD 1st	1		1	1																																	
75	BK1-012-109		Kabelstrang KL47/48, Taurus VD cable harness KL47/48 Taur.ev.	5.-/6. und 7.-/8.-VLL Gebläse 5.-/6. und 7.-/8.-VLL blower	1		1	2																																	
75	BK1-012-158		Kabelstrang Taurus VD cable harness ETaurus evaporat	Erweiterung 7.+ 8.- Bl.Gebläse extension for 7.+ 8.- bl.blowe			1																																		
76	BK1-000-378		Kabelstrang KL48/Taurus cable harness	Kabelbrücke Gebläsekodierung cable bridge blower coding	1		1																																		

BKL-4300249T01	BKL-4300249T02	BKL-4300249T03	BKL-4300249T04																	
----------------	----------------	----------------	----------------	--	--	--	--	--	--	--	--	--	--	--	--	--	--	--	--	--

Pos pos	Artikel Nr. Part no:	Bild picture	Bezeichnung description	Menge pro Anlage quantity per unit																	
77	BK1-011-268		Kabelstrang KL47/48 B+ cable harness KL47/48 B+	rt35², 1,10m, 2x M10 rt35², 1,10m, 2x M10	1			1													
77	BK1-011-375		Kabelstrang B+ cable harness B+	rt50², 1,10m, 2x M10 rt50², 1,10m, 2x M10				1													
78	BK1-012-110		Kabelstrang KL47/48 FL(10%) cable harness KL47/48 fresh ai	kleine Frischluftklappe small fresh air flap																	
79	H11-007-665		Anschlußstück pipe connector	2x M10, Messingbolzen 2x M10, brass bolt	1	1	1	1													



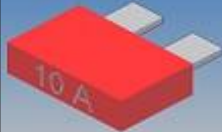
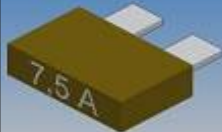
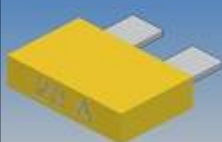

BKL-4300249T01	BKL-4300249T02	BKL-4300249T03	BKL-4300249T04																	
----------------	----------------	----------------	----------------	--	--	--	--	--	--	--	--	--	--	--	--	--	--	--	--	--

Pos pos	Artikel Nr. Part no:	Bild picture	Bezeichnung description		Menge pro Anlage quantity per unit																
80	H23-002-113		Gewindestift - Edelstahl threaded pin	M 8 / mit Flansch M 8 / stainless steel w/flange	1	1	1	1													
81	H11-001-359		Thermostat thermostat	mit Schutzkappe w.prot.fl./red/1°Coff/5,5°Ccon	1		1	1													
81	H11-003-440		Eissensor feeler gauge ice			1															
82	H11-001-281-1		Stellmotor servo-motor	24 V-DC 24 V-DC		1															

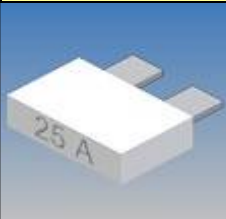

BKL-4300249T01	BKL-4300249T02	BKL-4300249T03	BKL-4300249T04																		
----------------	----------------	----------------	----------------	--	--	--	--	--	--	--	--	--	--	--	--	--	--	--	--	--	--

Pos pos	Artikel Nr. Part no:	Bild picture	Bezeichnung description	Menge pro Anlage quantity per unit																	
				BKL-4300249T01	BKL-4300249T02	BKL-4300249T03	BKL-4300249T04														
83	H11-000-024-1		Relais relay 24 Volt 20A W.m.Löschd. 24 Volt 20A W. w/diode	15		15	18														
84	H11-002-667		Sicherung fuse 10 amp / flat type conne 10 Amp./Flachsteck 10 amp./plug	1		1	1														
84	H11-002-657		Sicherung fuse 7,5 amp/spade terminal 7,5 Amp./Flachsteck 7,5 amp./flat socket		1																
85	H11-003-609		Sicherung fuse 20 amp/spade terminal 20 Amp./Flachsteck 20 amp./plug	6	13	6	8														

BKL-4300249T01	BKL-4300249T02	BKL-4300249T03	BKL-4300249T04																	
----------------	----------------	----------------	----------------	--	--	--	--	--	--	--	--	--	--	--	--	--	--	--	--	--

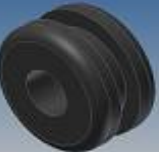
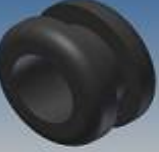

Pos pos	Artikel Nr. Part no:	Bild picture	Bezeichnung description	Menge pro Anlage quantity per unit																	
86	H11-002-659		Sicherung fuse 25 amp/spade terminal 25 Amp./Flachsteck 25 amp./plug	5		5	5														
87	H11-006-467		Raumtemperatursensor sensor inside air temperature Korb rund, Typ R25 4,7K / NTC basket round Typ R25 4,7K/NTC	1		1	1														
87	H11-003-434		Temperaturfühler temperature feeler gauge			2															
88	H59-000-332		Schutzgitter 300mm Durchm. grid protecting 300 mm diamete für Lüfter for fan	5		5	5														

BKL-4300249T01	BKL-4300249T02	BKL-4300249T03	BKL-4300249T04																	
----------------	----------------	----------------	----------------	--	--	--	--	--	--	--	--	--	--	--	--	--	--	--	--	--

Pos pos	Artikel Nr. Part no:	Bild picture	Bezeichnung description		Menge pro Anlage quantity per unit																
89	H11-001-333		Stecker f. Spule plug for spool 12/24V with dio	12/24 Volt / m.Diode 12/24 Volt / with diode	1	1	1	1													
90	H14-003-278		Gummitülle rubber socket	4x8x11mm / schwarz 4x8x11mm / black		1															
91	H14-000-219		Gummitülle rubber grommet/10 mm ø	10mmø 10mmø	1	1	1	1													
92	H14-000-216		Gummitülle rubber socket/45mmø	45mmØA / 15mmØI 45mmø	2	2	2	2													

Artikel Nr.
Part no.

BKL-4300249T01	BKL-4300249T02	BKL-4300249T03	BKL-4300249T04																	
----------------	----------------	----------------	----------------	--	--	--	--	--	--	--	--	--	--	--	--	--	--	--	--	--

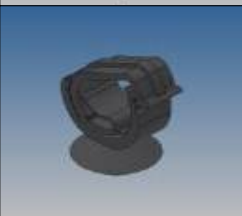
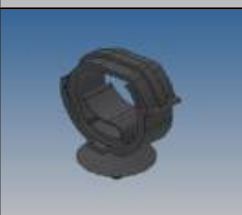
Pos pos	Artikel Nr. Part no:	Bild picture	Bezeichnung description		Menge pro Anlage quantity per unit																																				
93	H14-002-287		Kabelbinder cable fastener	205mm lg/4,6mm breit 190mm lg/4,6mm wide		2																																			
94	H14-003-223		Befestigungsbinder reinforcement binder	incl. Kabelbinder incl. cable clip		5																																			
95	H14-004-239		Kabelhalter cable holder	Bündel-ø max. 13,0 mm bundle-ø max. 13,0 mm		26	21	26	23																																
96	H14-004-240		Kabelhalter cable holder	Bündel-ø max. 20,0 mm bundle-ø max. 20,0 mm		5	16	5	10																																

Taurus-ET06





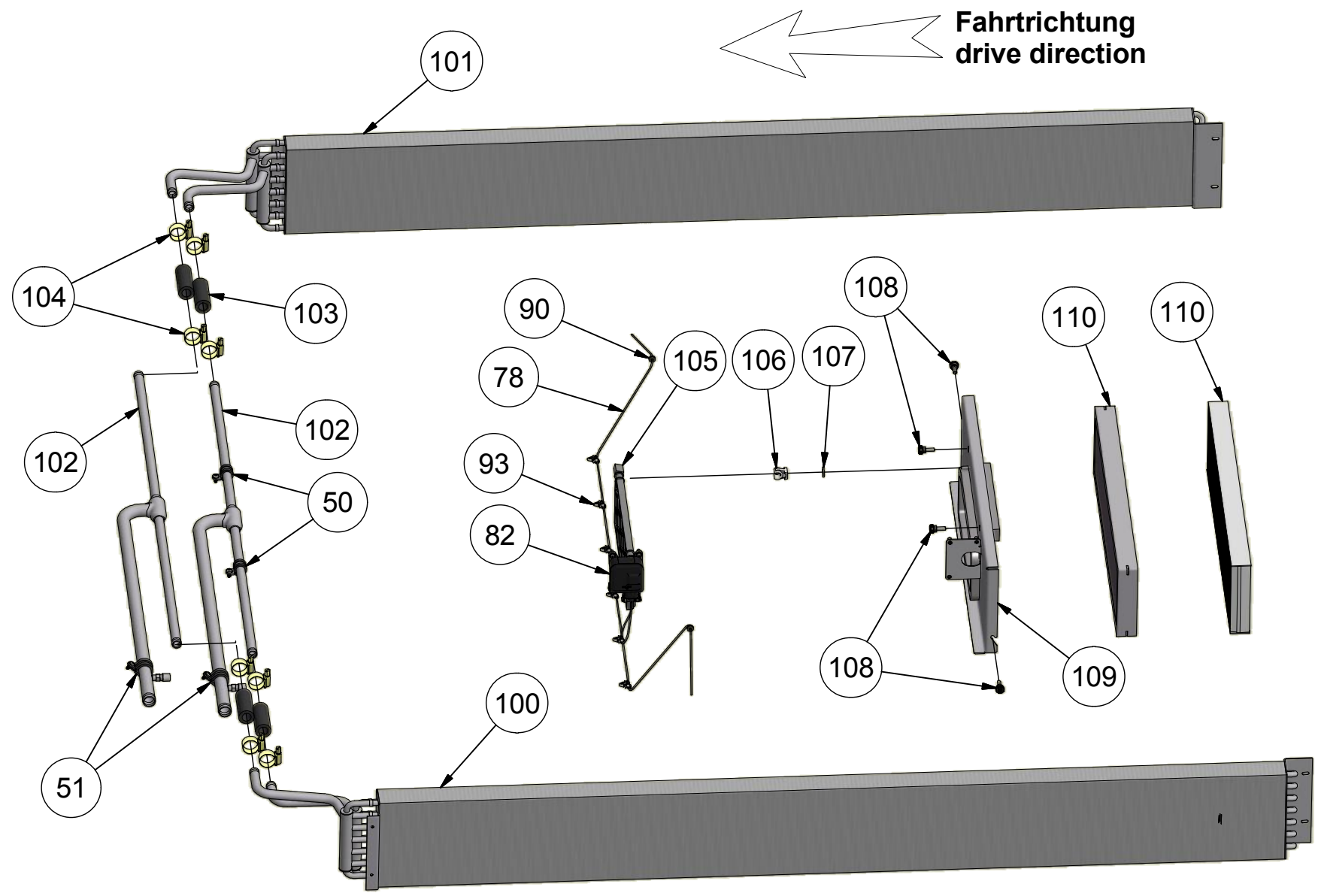

Thermo Systems

KÜHL- & KLIMANLAGEN D-34607 SCHWALMSTADT



BKL-4300249T01	BKL-4300249T02	BKL-4300249T03	BKL-4300249T04																	
----------------	----------------	----------------	----------------	--	--	--	--	--	--	--	--	--	--	--	--	--	--	--	--	--



Pos pos	Artikel Nr. Part no:	Bild picture	Bezeichnung description		Menge pro Anlage quantity per unit																																				
					BKL-4300249T01	BKL-4300249T02	BKL-4300249T03	BKL-4300249T04																																	
100	H40-030-066		Heizbatterie Links Taurus heating coil left Taurus	1600L07RH25,4/02RT22 1600L07RH25,4/02RT22		1																																			
101	H40-030-067		Heizbatterie Rechts Taurus heating coil right Taurus	1600L07RH25,4/02RT22 1600L07RH25,4/02RT22		1																																			
102	B52-220-053		Rohrleitung ø22 Al kpl. tubing Ø22 alum. compl.	Taurus Heizung Taurus Heating		2																																			
103	H14-005-408		Schlauch EPDM hose EPDM	NW16x5 mm NW16x5 mm		0,3																																			

Dachanlage Taurus
Roof Top Unit
Französisch
Spanisch

Ersatzteilliste / Spare Part List
Französisch / Spanisch

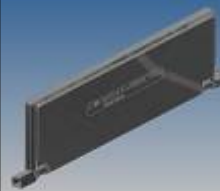

Artikel Nr.
Part no.

BKL-4300249T01	BKL-4300249T02	BKL-4300249T03	BKL-4300249T04																	
----------------	----------------	----------------	----------------	--	--	--	--	--	--	--	--	--	--	--	--	--	--	--	--	--

Pos pos	Artikel Nr. Part no:	Bild picture	Bezeichnung description		Menge pro Anlage quantity per unit																							
104	H14-001-226		Gewindeschelle threaded clamp	16-25 16-25		8																						
105	H59-000-345		Luftklappe air flap	275x110 275x105mm		1																						
106	H14-000-294		Rohr-Clips tube clip / 12mm	12mm 12mm		1																						
107	H15-001-313		Buchse bushing	ø18xø6,4x 2,0mm ø18xø6,4x 2,0mm		1																						

Artikel Nr.
Part no.

BKL-4300249T01	BKL-4300249T02	BKL-4300249T03	BKL-4300249T04																		
----------------	----------------	----------------	----------------	--	--	--	--	--	--	--	--	--	--	--	--	--	--	--	--	--	--

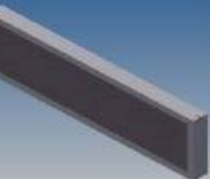
Pos pos	Artikel Nr. Part no:	Bild picture	Bezeichnung description		Menge pro Anlage quantity per unit																																						
108	H23-002-121		Rändelschraube M6 knurled screw M6	Schwarz M6x16 black M6x16		4																																					
109	B58-002-320		Frischluf mit Motor 12V/24V fresh air with motor 12V/24V	Taurus, ohne Filter,Leitung Taurus without filter, cable		1																																					
110	H14-004-483-1		Luftfilter air filter	518x 143x 35mm 518x 143x 35mm		1																																					
110	H14-006-434		Luftfilter (EU3) air filter (EU3)	518x 143x 35mm / Metall UL2 518x 143x 35mm / Metall UL2																																							