

**Ersatzteilliste
Kompressor**

**Spare part list
compressor**

**HGX34P-255-2A
HGX34P-315-2A
HGX34P-315-4A
HGX34P-380-4A**

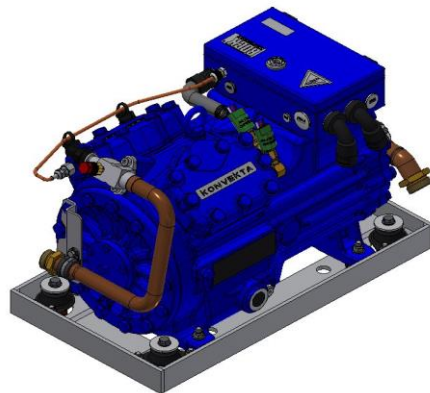

Version: A04

Konvekta AG
Am Nordbahnhof 5
34613 Schwalmstadt
Germany

Tel.: +49 (0) 66 91 / 76 – 0
Fax.: +49 (0) 66 91 / 76 - 200
Info@konvekta.com
www.konvekta.com

Allgemeines

Verehrter Kunde,
die vorliegende Ersatzteilliste enthält Angaben, die für die Ersatzteilbestellung erforderlich sind.

Nur Originalersatzteile gewährleisten Qualität, Sicherheit und Austauschbarkeit.
Die Firma KONVEKTA AG übernimmt keine Verantwortung für Schäden, die durch Verwendung firmenfremder Bauteile entstehen.

Manipulieren an den Bauteilen selbst oder an vorhandenen Einstellungen ist zu unterlassen!

Alle Originalersatzteile dürfen nur bestimmungsgemäß verwendet werden.
Wartungsarbeiten an Konvekta-Produkten dürfen nur durch geschultes Personal im Bereich Kälteanlagenbau durchgeführt werden. Bestehende Unfallverhütungsvorschriften und Gesetze müssen in jedem Fall eingehalten werden.

Weitere Hinweise entnehmen Sie bitte unseren Gewährleistungsrahmenbedingungen, allgemeingültigen Einbaurichtlinien und Sicherheitsvorschriften.

Bei Fragen oder Problemen steht Ihnen unser Servicedienst jederzeit gern zur Verfügung.

Durch Weiterentwicklung entstehende konstruktive und technische Änderungen behalten wir uns vor. Irrtum vorbehalten.

Die Abbildungen in dieser Liste sind unverbindlich.

Für eine Ersatzteilbestellung sind folgende Angaben erforderlich:

- Gerätetyp, Auftrags bzw. Seriennummer (siehe Typenschild)
- KONVEKTA Bestellnummer der gewünschten Teile
- Bezeichnung der Teile (siehe entsprechende Texterklärung)
- Stückzahl
- Ihre genaue Versandanschrift
- Versandart (z.B. Post, Fracht oder Express)

Wir wünschen Ihnen eine problemlose und störungsfreie Wartung / Reparatur Ihrer Anlage.

Die Geschäftsleitung

Generally

Dear customer,
the spare part list you have at hand contains specifications which are necessary for ordering spare parts.

Only original spare parts guarantee quality, safety and exchangeability.
KONVEKTA AG does not assume responsibility for damages which are caused by employment of parts from other companies.

It has to be refrained from manipulating parts or existing adjustments!

All original spare parts may be used only in accordance with the requirements. Servicing work on Konvekta products may be carried out only by trained staff in the area of Refrigerant plant construction. Existing accident prevention regulations and statute must be kept, in any case.

For further information please refer to our guarantee, warranty and safety instructions.

In case of arising problems our after-sales service is at your disposal at any time.

We reserve the right of constructional and technical alterations resulting from further development. Mistake reserve.

The illustrations in this list are without obligation.

When ordering spare parts the following specifications have to be made:

- type of unit, order confirmation no. / resp. Serial no. (please refer to the type plate)
- KONVEKTA part-no. Of the ordered parts.
- specification of the parts (pls refer to the corresponding text description)
- quantity
- your exact delivery address
- means of transport (for instance Postal Service, freight or express)

We hope you have a problem and trouble-free service / repair of your unit.

The management

Änderungsverlauf History of modification

Version version	Datum date	Name name	Bemerkung remark	Datei file
a00	16.07.18	S. Pfluger	Datei erstellt	ET-BKO-HGX34P006.xls
a01	15.07.19	S. Pfluger	BKO-HGX34P012 ergänzt / added	ET-BKO-HGX34P006.xls
a02	24.01.20	S. Pfluger	BKO-HGX34P013 ergänzt / added	ET-BKO-HGX34P006.xls
a03	15.06.21	S. Pfluger	Pos.15 : Verschraubungen am Klemmkasten geä. / changed fittings (Pos.15) at terminal box	ET-BKO-HGX34P006.xls
a04	06.08.21	S. Pfluger	BKO-HGX34P014 - 017 ergänzt / added	ET-BKO-HGX34P006.xls

KOHGX34P006-ET00



Thermo Systems

KÜHL- & KLIMANLAGEN D-34607 SCHWALMSTADT



Artikelnummer Kompressor
Partnumber Compressor



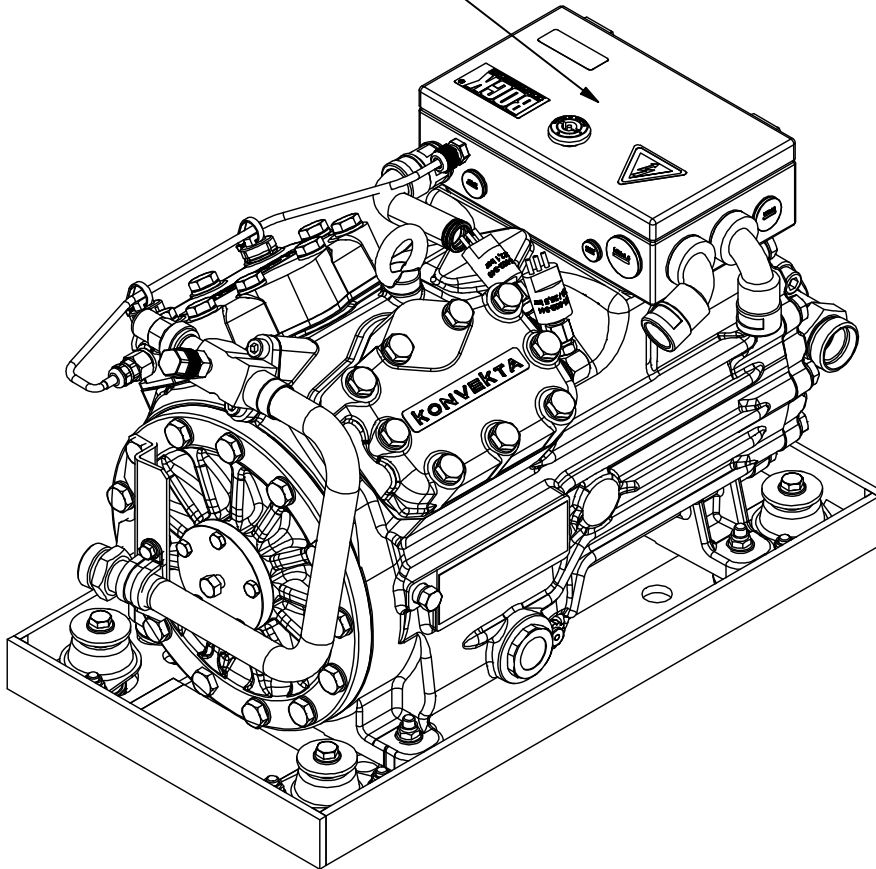

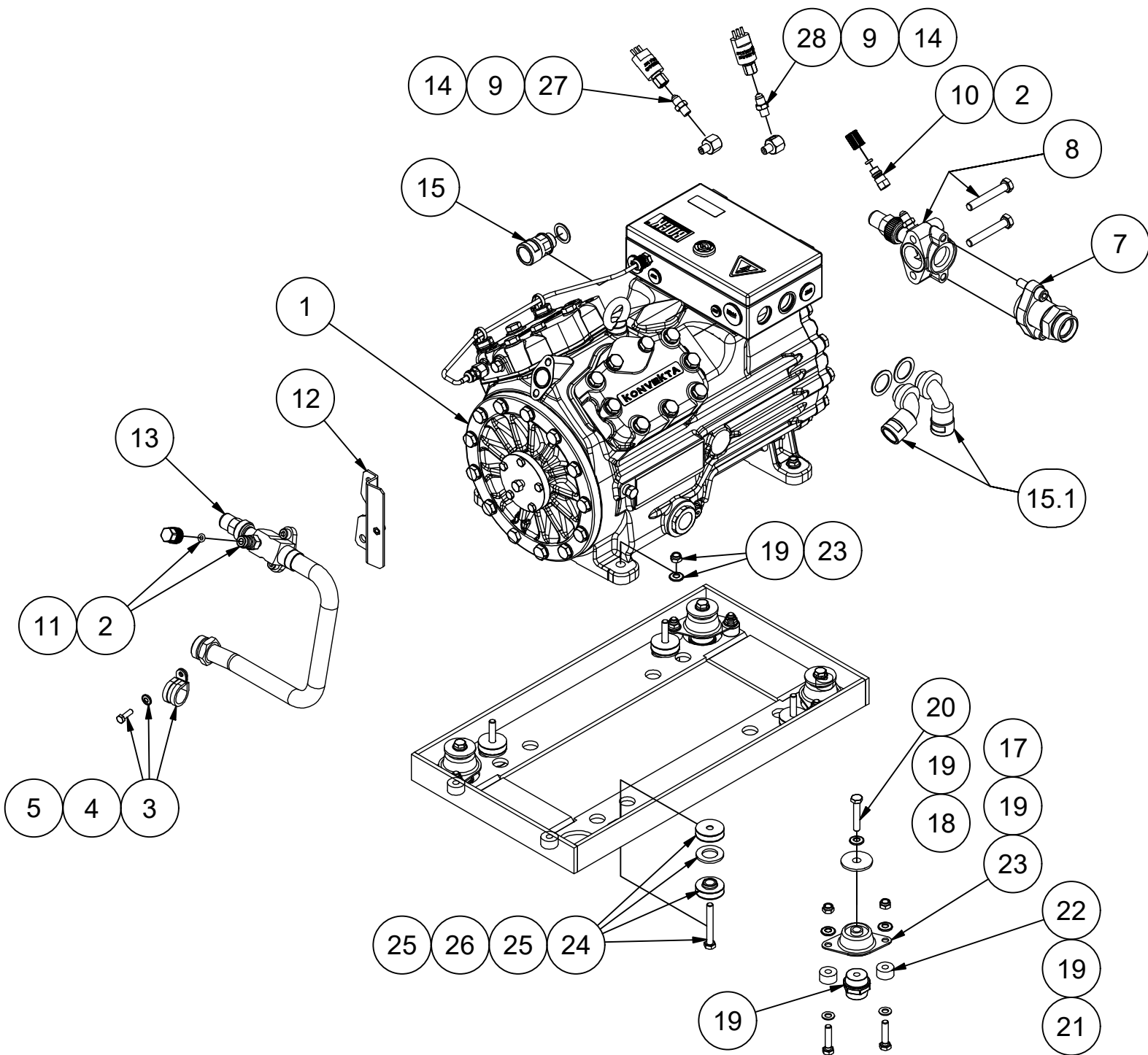

Typenschild Kompressor
ID-Label compressor

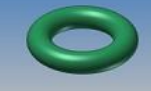
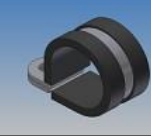

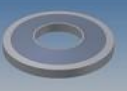







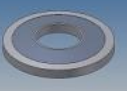

Pos pos	Artikel Nr. Part no:	Bild picture	Bezeichnung description	Menge pro Anlage quantity per unit														
				BKO-HGX34P002	BKO-HGX34P004	BKO-HGX34P005	BKO-HGX34P006	BKO-HGX34P007	BKO-HGX34P008	BKO-HGX34P009	BKO-HGX34P010	BKO-HGX34P011	BKO-HGX34P012	BKO-HGX34P013	BKO-HGX34P014	BKO-HGX34P015	BKO-HGX34P016	BKO-HGX34P017
1	H13-004-543		Hubkolbenverdichter HGX34P 315-2A 380-420V S-3-50Hz compressor reciprocating HGX34P 315-2A 380-420V S-3-50Hz	-	1	-	-	-	-	-	-	-	1	-	-	-	1	-
	H13-004-544		Hubkolbenverdichter HGX34P 255-2A 380-420V S-3-50Hz compressor reciprocating HGX34P 255-2A 380-420V S-3-50Hz	1	-	-	-	-	-	-	-	-	-	-	-	-	-	-
	H13-005-568		Hubkolbenverdichter HGX34P 255-2A 380-420V S-3-50Hz+LR compressor reciprocating HGX34P 255-2A 380-420V S-3-50Hz+LR	-	-	1	-	-	-	-	-	-	-	-	-	-	-	-
	H13-005-589		Hubkolbenverdichter HGX34e 380-4A 380-420V S-3-50Hz compressor reciprocating HGX34e 380-4A 380-420V S-3-50Hz	-	-	-	1	1	-	1	-	-	-	-	1	-	-	-
	H13-006-543		Hubkolbenverdichter HGX34e 315-4A 380-420V S-3-50Hz compressor reciprocating HGX34e 315-4A 380-420V S-3-50Hz	-	-	-	-	-	1	-	-	-	-	-	-	-	-	-
	H13-006-549		Hubkolbenverdichter HGX34e 380-4A 380-420V S-3-50Hz+LR compressor reciprocating HGX34E 380-4A 380-420V S-3-50 w. cap.regul.	-	-	-	-	-	-	-	1	1	-	-	-	1	-	-
	H13-006-556		Hubkolbenverdichter HGX34e 315-2A 380-420V S-3-50Hz + LR compressor reciprocating HGX34E 315-2A 380-420V S-3-50Hz + LR	-	-	-	-	-	-	-	-	-	-	1	-	-	-	1
2	H14-001-149		O-Dichtring 7/16", NW 6, R134a o-ring sealing 7/16", NW 6, R134a	2	2	2	2	2	2	2	2	2	2	2	2	2	2	2
3	H14-000-206		Schlauchselle 23/15 hose clip 23/15	1	1	1	1	1	-	-	1	1	1	1	1	1	1	1
4	H22-000-229		Sechskantschraube M6x20 /ISO 4017 /A2 screw M6x20 /ISO 4017 /A2	1	1	1	1	1	-	-	1	1	1	1	1	1	1	1

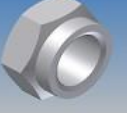
Pos pos	Artikel Nr. Part no:	Bild picture	Bezeichnung description	Menge pro Anlage quantity per unit														
				BKO-HGX34P002	BKO-HGX34P004	BKO-HGX34P005	BKO-HGX34P006	BKO-HGX34P007	BKO-HGX34P008	BKO-HGX34P009	BKO-HGX34P010	BKO-HGX34P011	BKO-HGX34P012	BKO-HGX34P013	BKO-HGX34P014	BKO-HGX34P015	BKO-HGX34P016	BKO-HGX34P017
5	H21-001-113		Sperrkantscheibe M6 BN 208010 detent edge lock washer M6 BN 208010	1	1	1	1	1	-	-	1	1	1	1	1	1	1	1
6	H13-003-553		Flanschabsperventil FK 50 flange shut-off valve FK 50	1	1	1	1	1	1	1	1	1	1	1	1	1	1	1
7	B13-AC2-565		Flansch M36x2 Anschluß gerade flange M36x2 FK4+5 M36x2 FK 4+5	1	1	1	1	-	-	-	1	-	-	-	-	-	-	-
	B13-AN2-565		Flansch M36x2 FK4+5 45° flange M36x2 FK4+5 M36x2 FK 4+5 45°	-	-	-	-	1	-	-	-	1	1	1	1	1	1	1
8	H22-000-406		Schraube M10 x 65/ DIN 931/ vz screw M10 x 65/ DIN 931/ vz	2	2	2	2	2	2	2	2	2	2	2	2	2	2	2
9	H14-000-175		Einschraubstutzen 7/16"UNFx1/8"NPTF bushing threaded 7/16"-1/8" NP 7/16" - 1/8"	2	2	2	2	3	2	2	2	3	3	3	3	3	3	3
10	H12-000-943		Füllventil (R134a) f. Saugseite (Retro) filling valve R134a suction for suction side (retro)	1	1	1	1	1	1	1	1	1	1	1	1	1	1	1
11	H12-000-944		Füllventil (R134a) f. Druckseite (Retro) valve filler R134a suction for pressure side (retro)	1	1	1	1	1	1	1	1	1	1	1	1	1	1	1
12	B56-120-222		Z-Profil kpl. Saugrohrbefestigg. HGX34P Z-Profil compl. fixing suction pipe HGX34P	1	1	1	1	1	-	-	1	1	1	1	-	-	-	-
12	B56-133-161		Befestigungswinkel kpl. Druckleitung HGX34P fixing bracket compl. pressure pipe HGX34P	-	-	-	-	-	-	-	-	-	-	-	1	1	1	1

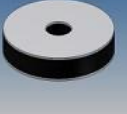
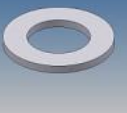
Pos pos	Artikel Nr. Part no:	Bild picture	Bezeichnung description	Menge pro Anlage quantity per unit														
				BKO-HGX34P002	BKO-HGX34P004	BKO-HGX34P005	BKO-HGX34P006	BKO-HGX34P007	BKO-HGX34P008	BKO-HGX34P009	BKO-HGX34P010	BKO-HGX34P011	BKO-HGX34P012	BKO-HGX34P013	BKO-HGX34P014	BKO-HGX34P015	BKO-HGX34P016	BKO-HGX34P017
13	B51-220-186		Rohrleitung Ø22 Cu tubing Ø22 Cu f. Saugseite (Retro)KP aus for suction side (retro) CP out	1	1	1	1	1	-	-	1	1	1	1	-	-	-	-
13	B51-220-214		Rohrleitung Ø22 Cu kpl. tubing Ø22 Cu complete KP aus -> Schlauch ein compr. out -> hose in	-	-	-	-	-	1	1	-	-	-	-	-	-	-	-
13	B51-220-218		Rohrleitung Ø22 Cu kpl. tubing Ø22 Cu complete KP aus -> Schlauch ein compr. out -> hose in	-	-	-	-	-	-	-	-	-	-	-	1	1	1	1
14	H14-001-165		Einschraubstutzen screw union 1/8" 1/8" 1/8"	2	2	2	2	3	2	2	2	3	3	3	3	3	3	3
15	H11-005-673 <i>bis 03.2021</i>		Verschraubung bolting M20x1,5 / 90° / NW17 M20x1,5 / 90° / NW17	3	3	3	3	3	3	3	3	3	3	3	-	-	-	-
15	H11-005-672 <i>ab 04.2021</i>		Verschraubung bolting M20x1,5 / gerade / NW17 M20x1,5 / straight / NW17	1	1	1	1	1	1	1	1	1	1	1	1	1	1	1
15.1	H11-011-633 <i>ab 04.2021</i>		Verschraubung bolting M25x1,5 / 90° / NW17 M25x1,5 / 90° / NW17	2	2	2	2	2	2	2	2	2	2	2	2	2	2	2
16	H14-001-354		Keramisolator Ceramicisolator M8 H=30 / Ø=27 M8 high=30 / Ø=27	4	4	4	4	4	4	4	4	4	4	4	4	4	4	4
17	H14-002-229		Konus-Lager 45 S bearing cone-type 45 Shore 30mm hoch 49mmØ 30mm high / 49mm ø	4	4	4	4	4	4	4	4	4	4	4	4	4	4	4
18	B56-210-024		Absatzscheibe centering disk Ø8,5mm (Ø16 Ø40) x7,5mm ø40x3,5 ø16x4 ø8,5	4	4	4	4	4	4	4	4	4	4	4	4	4	4	4

Pos pos	Artikel Nr. Part no:	Bild picture	Bezeichnung description	Menge pro Anlage quantity per unit														
				BKO-HGX34P002	BKO-HGX34P004	BKO-HGX34P005	BKO-HGX34P006	BKO-HGX34P007	BKO-HGX34P008	BKO-HGX34P009	BKO-HGX34P010	BKO-HGX34P011	BKO-HGX34P012	BKO-HGX34P013	BKO-HGX34P014	BKO-HGX34P015	BKO-HGX34P016	BKO-HGX34P017
19	H21-001-114		Sperrkantscheibe M8 BN 208010 detent edge lock washer M8 BN 208010	24	24	24	24	24	24	24	24	24	24	24	24	24	24	24
20	H22-000-375		Schraube M 8x 45 /ISO4014/A2 screw M 8x 45 /ISO4014/A2	4	4	4	4	4	4	4	4	4	4	4	4	4	4	
21	22526030		Schraube M8 x 35/DIN933/V2A screw M8 x 35/DIN933/V2A	8	8	8	8	8	8	8	8	8	8	8	8	8	8	
22	B57-030-286		Abstandsbochse ø22.0xø8.0x12.0 bushing spacer ø22.0xø8.0x12.0	4	4	4	4	4	4	4	4	4	4	4	4	4	4	
23	H21-000-065		Mutter M 8 / DIN 982 / A2 nut M 8 / DIN 982 / A2	12	12	12	12	12	12	12	12	12	12	12	12	12	12	
24	H22-000-369		Schraube M 8x 60 /ISO4014/A2 screw M 8x 60 /ISO4014/A2	4	4	4	4	4	4	4	4	4	4	4	4	4	4	
25	H14-003-270		Ringpuffer 60 Shore Ø36xØ8,5xØ18x10hx4mm ring cushion 60 shore Ø36xØ8,5xØ18x10hx4mm	8	8	8	8	8	8	8	8	8	8	8	8	8	8	
26	B56-160-464		Scheibe di=20 da=35 t=3,0 disk di=20 da=35 t=3,0	4	4	4	4	4	4	4	4	4	4	4	4	4	4	
27	H11-002-343		Unterdruckschalter 7/16"i 0,3-2,1 bar R134a/max.1A low pressure switch 7/16"i 0,3-2,1 bar R134a/max.1A	1	1	1	1	1	1	1	1	1	1	1	1	1	1	
28	H11-002-344		Überdruckschalter 7/16"i 18,0-25,5 bar R134a/max.1A high pressure switch 7/16"i 18,0-25,5 bar R134a/max.1A	1	1	1	1	1	1	1	1	1	1	1	1	1	1	